



# Process Equipment

Air-Operated Pumps for Process Industries



PROVEN QUALITY. LEADING TECHNOLOGY.

# SUPERIOR PUMPING TECHNOLOGY



Double Diaphragm/  
Piston Evacuation

## 55 Gallon Drum Transfer and Supply

Pump from your 55 gallon drums with our double diaphragm or piston evacuation pumps. They offer flow rates up to 12 gpm, and are available in: aluminum, carbon steel, stainless steel, polypropylene and acetal materials of construction.



Husky™  
Air-Operated  
Double Diaphragm

## Bulk Tank Supply and Evacuation

Husky™ air-operated double diaphragm pumps are ideal for unloading above or below ground tanks of any size. They are available in a wide range of sizes including: 1/4 in (6.3 mm), 3/8 in (9.4 mm), 1/2 in (12.7 mm), 3/4 in (19.1 mm), 1 in (25.4 mm), 1-1/2 in (38.1 mm), 2 in (50.8 mm) and 3 in (76.2 mm).



Pneumatic

## Maintenance and Production Cleaning

Designed for rugged dependability, pneumatically-driven pumps offer simplicity in design, operation and maintenance. They provide high pressure for water and cleaning chemicals up to 3,000 psi and flow rates up to 9 gpm.

### Key Fluids

- Paints, stains, coatings, inks and dyes
- Chemicals
- Acids
- Corrosive and abrasive fluids
- Lubricants
- Ceramic glazes
- Sludge, slurry and waste fluid
- Soaps, detergents and solvents

### Key Applications

- Transferring fluids from drums
- Sanitizing buildings and equipment
- Removing waste fluid
- Unloading fluids
- Draining tanks and sumps
- Transferring high temperature acids
- Skimming and transferring oil
- Servicing lubrication equipment

# TRANSFER PUMPS

**Air-Powered for High Reliability at an Affordable Price!**

Perfect for low to medium viscosity fluids and shear sensitive materials. Transfer pumps offer superior reliability at an affordable price!

## Piston Pumps

Part Number	Pump Material	Length	Seat Type	Packings	Certificate
226940	Carbon Steel	Drum	Disc	PTFE/Leather	UL, CE
226941	Carbon Steel	Drum	Disc	Polyethylene	UL, CE
226942	Stainless Steel	Drum	Ball	Polyethylene	UL, CE
226944	Carbon Steel	Stubby	Disc	Polyethylene	UL, CE
226945	Stainless Steel	Stubby	Ball	Polyethylene	UL, CE
226946	Carbon Steel	Drum	Disc	PTFE	CE
237129	Stainless Steel	Drum	Ball	PTFE	CE
237132	Stainless Steel	Stubby	Ball	PTFE	CE

- Flow rates up to 5 gpm
- Drum length versions have inlet immersed in material for quicker priming of heavier fluid
- Available with optional stubby and drum length models
- Air-powered for high reliability and low cost
- Plate (flat) check options for lower viscosity fluids



Fast-Flo® 1:1

## Husky Transfer Pumps

Part Number	Description	Tube Type
233051	D52911	Polypropylene tube
233052	D51211	Stainless Steel tube
233053	D51211	Aluminum tube
233054	D53266	Aluminum tube
233055	D53277	Aluminum tube
233056	D53211	Aluminum tube
233057	D54311	Stainless Steel tube
237132	Stainless Steel	Ball

- Suction tube is immersed inside the drum – not the pump
- Quick-priming and immediate flow of product
- Handles fluid viscosities up to 5,000 cps and solids up to 0.09 in (2.29 mm)
- Provides air tight seal for moisture-sensitive fluids
- Bung adapter fits into any 2 in (50.8 mm) bung opening







Husky 515 Transfer



Husky 716 Transfer



# AIR-OPERATED DOUBLE DIAPHRAGM PUMPS

## Model Overview

				
Model	<b>Husky 205</b>	<b>Husky 307</b>	<b>Husky 515</b>	<b>Husky 716</b>
Connection Size	1/4 in (6.3 mm)	3/8 in (9.4 mm)	1/2 in (12.7 mm) or 3/4 in (19.1 mm)	3/4 in (19.1 mm)
Maximum Flow Rate*	5 gpm (19 lpm)	7 gpm (26 lpm)	15 gpm (57 lpm)	16 gpm (61 lpm)
Materials of Construction Available	Polypropylene, Kynar (PVDF), Acetal	Polypropylene, Acetal	Polypropylene, Kynar (PVDF), Acetal	Aluminum, 316 Stainless Steel
Center Section Available	Polypropylene	Coated Aluminum	Polypropylene	Polypropylene
Typical Fluids Handled	Waterborne materials, paint, coatings, inks, car wash chemicals	Paints, lubricants, inks, stains, solvents, coatings and dyes	Cleaning fluids, detergents, chemicals, ceramic glazes, inks	Oil, water and most solvents
Manual Number	308652	308553	308981	308981

\*Flow rates are with muffler and do not vary based on diaphragm material

Note: Husky 307 and Husky 3275 are only available with standard air valves. All other pumps are available with standard or remote air valves

				
Model	<b>Husky 1040</b>	<b>Husky 1590</b>	<b>Husky 2150</b>	<b>Husky 3275</b>
Connection Size	1 in (25.4 mm)	1-1/2 in (38.1 mm)	2 in (50.8 mm)	3 in (76.2 mm)
Maximum Flow Rate*	40 gpm (151 lpm)	90 gpm (340 lpm)	150 gpm (568 lpm)	275 gpm (1041 lpm)
Materials of Construction Available	Polypropylene, Kynar (PVDF), Aluminum, 316 Stainless Steel	Polypropylene, Kynar (PVDF), Aluminum, 316 Stainless Steel	Polypropylene, Kynar (PVDF), Aluminum, 316 Stainless Steel, Ductile Iron	Aluminum
Center Section Available	Coated Aluminum, 316 Stainless Steel	Coated Aluminum, 316 Stainless Steel	Coated Aluminum, 316 Stainless Steel	Coated Aluminum
Typical Fluids Handled	Chemicals, contaminated surface water, acids, adhesives and varnishes	Chemicals, corrosive fluids, acids, latex, abrasive fluids, slurries and sludge	Acids, gases, ship cleaning, stripping chemicals, alkalis, solvents, paints and varnishes	Chemicals, bulk paint resins and ceramic slip
Manual Number	Plastic: 308443 Metal: 308479	Plastic: 308549 Metal: 308441	Plastic: 308550 Metal: 308368	308639

\*Flow rates are with muffler and do not vary based on diaphragm material

Note: Husky 307 and Husky 3275 are only available with standard air valves. All other pumps are available with standard or remote air valves

# THE HUSKY DIAPHRAGM PUMP ADVANTAGE

Reduce Downtime and Save Money!

## Graco Air Valve

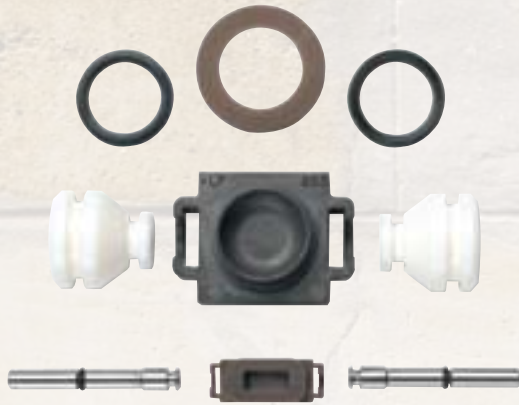

## Competitor Air Valve

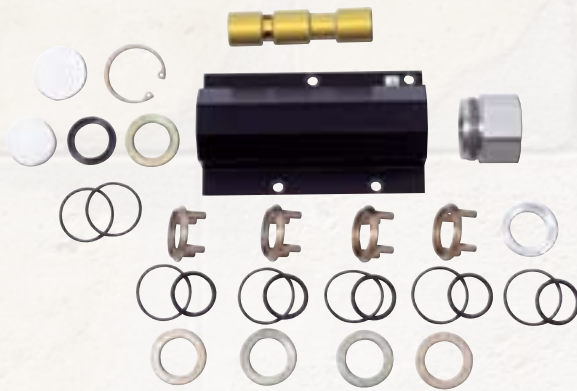

When it comes to chemical, sanitary and ink applications, it's tough to beat these Graco pumps!

Our Husky air-operated double diaphragm pumps are loaded with features to help you get the job done right, every time, and are built to save you money.

## The Simplicity of the Husky Air Valve

Our Husky air-operated double diaphragm pumps feature extremely reliable, externally serviceable air valves – making these Husky pumps among the best in the industry!



Top view of Husky Air Valve

## Features and Benefits

- Fewer moving parts means increased durability and less repair time
- Three-way pilot valve for true non-sticking operation
- Externally serviceable for quick, inexpensive repairs
- The elimination of o-rings and a spool valve prevents centering; a common problem with competitive pumps
- Lube-free for cleaner operation – essential when handling food products

# DIAPHRAGM PUMPS ORDERING INFORMATION

## Diaphragm Pump Designation

Part numbers are located on ID tag on center section of all Husky diaphragm pumps.

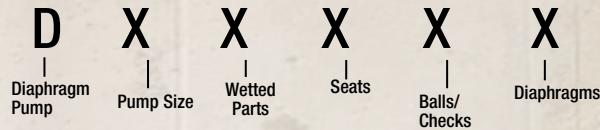

PUMP SIZE (AIR MOTOR TYPE AND MATERIAL)	WETTED PARTS	SEATS	BALLS	DIAPHRAGM
1 = 1/4" (6.35 mm) Standard: polypropylene center section	1 = Acetal (npt)	2 = Acetal	1 = PTFE	1 = PTFE
2 = 1/4" (6.35 mm) Remote: polypropylene center section	2 = Poly (npt)	3 = Stainless Steel	2 = Acetal	5 = TPE
3 = 3/8" (9.52 mm) Standard: polypropylene center section	3 = Aluminum (npt)	4 = Hardened SST	3 = Stainless Steel	6 = Santoprene
5 = 1/2" (12.7 mm) Standard: polypropylene center section	4 = Stainless Steel (npt)	5 = TPE	4 = Hardened SST	7 = Buna N
4 = 1/2" (12.7 mm) Remote: polypropylene center section	5 = PVDF (npt)	6 = Santoprene	5 = TPE	8 = FKM
5 = 3/4" (19.05 mm) Standard: polypropylene center section	6 = Ductile Iron (npt)	7 = Buna N	6 = Santoprene	G = Geolast
4 = 3/4" (19.05 mm) Remote: polypropylene center section		8 = FKM	7 = Buna N	
7 = 1" (25.4 mm) Standard: aluminum center section	A = Acetal * (bsp)	9 = Polypropylene	8 = FKM	
8 = 1" (25.4 mm) Remote: aluminum center section	B = Poly * (bsp)	A = PVDF	9 = Polypropylene	
R = 1" (25.4 mm) Standard: stainless steel center section	C = Aluminum (bsp)	G = Geolast	A = PVDF	
B = 1-1/2" (38.1 mm) Standard: aluminum center section	D = Stainless Steel (bsp)		G = Geolast	
C = 1-1/2" (38.1 mm) Remote: aluminum center section	E = PVDF (bsp)	B = SST with FKM seal		
T = 1-1/2" (38.1 mm) Standard: stainless steel center section	F = Ductile Iron (bsp)	C = Santoprene with FKM seal		
F = 2" (50.8 mm) Standard: aluminum center section				
G = 2" (50.8 mm) Remote: aluminum center section	H = 2 npt Alum Extended			
V = 2" (50.8 mm) Standard: stainless steel center section	G = 2 bsp Alum Extended			
K = 3" (76.2 mm) Standard: aluminum center section				

\* = BSP plastic in 1/2" (12.7mm) pumps  
 ≥1" Plastic pumps flange connections  
 3" Aluminum pumps flange connections

## Diaphragm Pump Kit Designation

When selecting a kit, use the same code numbers as for the pumps regarding pump size, seat, ball/ checks and diaphragm.

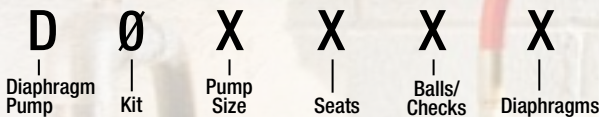

Pump Size	Seats	Balls/Checks	Diaphragm
1 = 1/4 in (6.35 mm)	0 = No seat	1 = PTFE	1 = PTFE
3 = 3/8 in (9.52 mm)	2 = Acetal	2 = Acetal	5 = TPE
5 = 1/2 in (12.7 mm) and 3/4 in (19.05 mm)	3 = Stainless Steel	3 = Stainless Steel	6 = Santoprene
7 = 1 in (25.4 mm) metal pump	4 = Hardened SST	4 = Hardened SST	7 = Buna-N
8 = 1 in (25.4 mm) plastic pump	5 = TPE	5 = TPE	8 = FKM
B = 1-1/2 in (38.1 mm) metal pump	6 = Santoprene	6 = Santoprene	G = Geolast
C = 1-1/2 in (38.1 mm) plastic pump	7 = Buna N	7 = Buna-N	
F = 2 in (50.8 mm) metal pump	8 = FKM	8 = FKM	0 = No Diaphragm
G = 2 in (50.8 mm) plastic pump	9 = Poly	9 = Poly	
K = 3 in (76.2 mm)	A = PVDF	A = PVDF	
	B = SST with viton seal	G = Geolast	
	C = Santoprene with PVDF seal		
	G = Geolast	0 = No Balls/Checks	

# HYDRA-CLEAN® PUMPS

## On-Demand High Pressure Cleaning Pumps

Graco Hydra-Clean heavy-duty pressure washers support multiple guns and are perfect for use in a variety of in-plant cleaning applications.

### Hydra-Clean NXT® Pumps

Package Order No.	247549 or 247550	247551 or 247552	247553 or 247554
Pump Assembly Part No.	N34DN0	N65DN0	N65DN0
Pump Lower Part No.	247599	241648	687055
Construction	SST	SST	SST
Standard Seal Repair Kit	247881	222880	See manual 311825
Construction	UHMWPE/ CF-PTFE	UHMWPE/ CF-PTFE	UHMWPE/ CF-PTFE
Optional Seal Repair Kits	207581	222875	222845
Construction	PTFE	UHMWPE/ PTFE	UHMWPE/ PTFE
Motor Repair Kit	See manual 311238	See manual 311238	See manual 311238

### Features and Benefits

- Versatility in variable pressure, flow and chemical injection provides best cleaning action
- Available with chemical injectors and accumulators
- On demand supply pump stops when valve is closed and runs when valve open
- Cleaning chemical passes through pump, providing concentrate levels above 5%
- Supports multiple guns
- For use with cold or hot water up to 200°F (93°C)

### Typical Applications

- Oil refineries
- Vehicle fleets, buses and transit systems
- Heavy construction equipment, off-highway vehicles
- General industrial equipment
- Sanitizing

NXT  
Wall Mount



NXT  
Cart Mount



NXT  
Cart Mount  
(View from back)





## ABOUT GRACO

### PROVEN QUALITY. LEADING TECHNOLOGY.

Founded in 1926, Graco is a world leader in fluid handling systems and components. Graco products move, measure, control, dispense and apply a wide range of fluids and viscous materials used in vehicle lubrication, commercial and industrial settings.

The company's success is based on its unwavering commitment to technical excellence, world-class manufacturing and unparalleled customer service. Working closely with qualified distributors, Graco offers systems, products and technology that set the quality standard in a wide range of fluid handling solutions. Graco provides equipment for spray finishing, protective coating, paint circulation, lubrication, and dispensing sealants and adhesives, along with power application equipment for the contractor industry. Graco's ongoing investment in fluid management and control will continue to provide innovative solutions to a diverse global market.

## GRACO LOCATIONS

### MAILING ADDRESS

P.O. Box 1441  
Minneapolis, MN 55440-1441  
Tel: 612-623-6000  
Fax: 612-623-6777

### AMERICAS

#### MINNESOTA

Worldwide Headquarters  
Graco Inc.  
88-11th Avenue N.E.  
Minneapolis, MN 55413

### EUROPE

#### BELGIUM

European Headquarters  
Graco N.V.  
Industrieterrein-Oude Bunders  
Slakweidestraat 31  
3630 Maasmechelen,  
Belgium  
Tel: 32 89 770 700  
Fax: 32 89 770 777

### ASIA PACIFIC

#### AUSTRALIA

Graco Australia Pty Ltd  
Suite 17, 2 Enterprise Drive  
Bundoora Victoria 3083  
Australia  
Tel: 61 3 9467 8558  
Fax: 61 3 9467 8559

#### CHINA

Graco Hong Kong Ltd.  
Shanghai Representative Office  
Room 118 1st Floor  
No.2 Xin Yuan Building  
No.509 Cao Bao Road  
Shanghai, P.R. China 200233  
Tel: 86 21 649 50088  
Fax: 86 21 649 50077

#### INDIA

Graco Hong Kong Ltd.  
India Liaison Office  
Room 432, Augusta Point  
Regus Business Centre 53  
Gurgaon, Haryana, India 122001  
Tel: +91 124 435 4208  
Fax: +91 124 435 4001

#### JAPAN

Graco K.K.  
1-27-12 Hayabuchi  
Tsuzuki-ku  
Yokohama City, Japan 2240025  
Tel: 81 45 593 7300  
Fax: 81 45 593 7301

#### KOREA

Graco Korea Inc.  
Shinhan Bank Building  
4th Floor #1599  
Gwanyang-Dong, Dongan-Ku,  
Anyang-Si, Gyunggi-Do,  
Korea 431-060  
Tel: 82(Korea) 31 476 9400  
Fax: 82(Korea) 31 476 9801

## SALES/ DISTRIBUTION/ SERVICE

Call today for product information or to request a demonstration.

**877-84GRACO (1-877-844-7226)** or visit us at [www.graco.com](http://www.graco.com).

Graco Inc. is registered to I.S. EN ISO 9001

North America  
Customer Service  
800-328-0211  
Fax 877-340-6427